











NAT0618

HOJA INSTRUCCIONES
INSTRUCTIONS LEAFLET
BEDIENUNGSANLEITUNG
NOTICE DE MONTAGE

PIEZAS Y HERRAMIENTAS
PARTS AND TOOLS
TEILE UND WERKZEUGE
PIÈCES FOURNIES

A  5	B  1	C  5	D  M6x10 6	E  6
F  2	G  1	H  2	J  M6x21 2	M  6

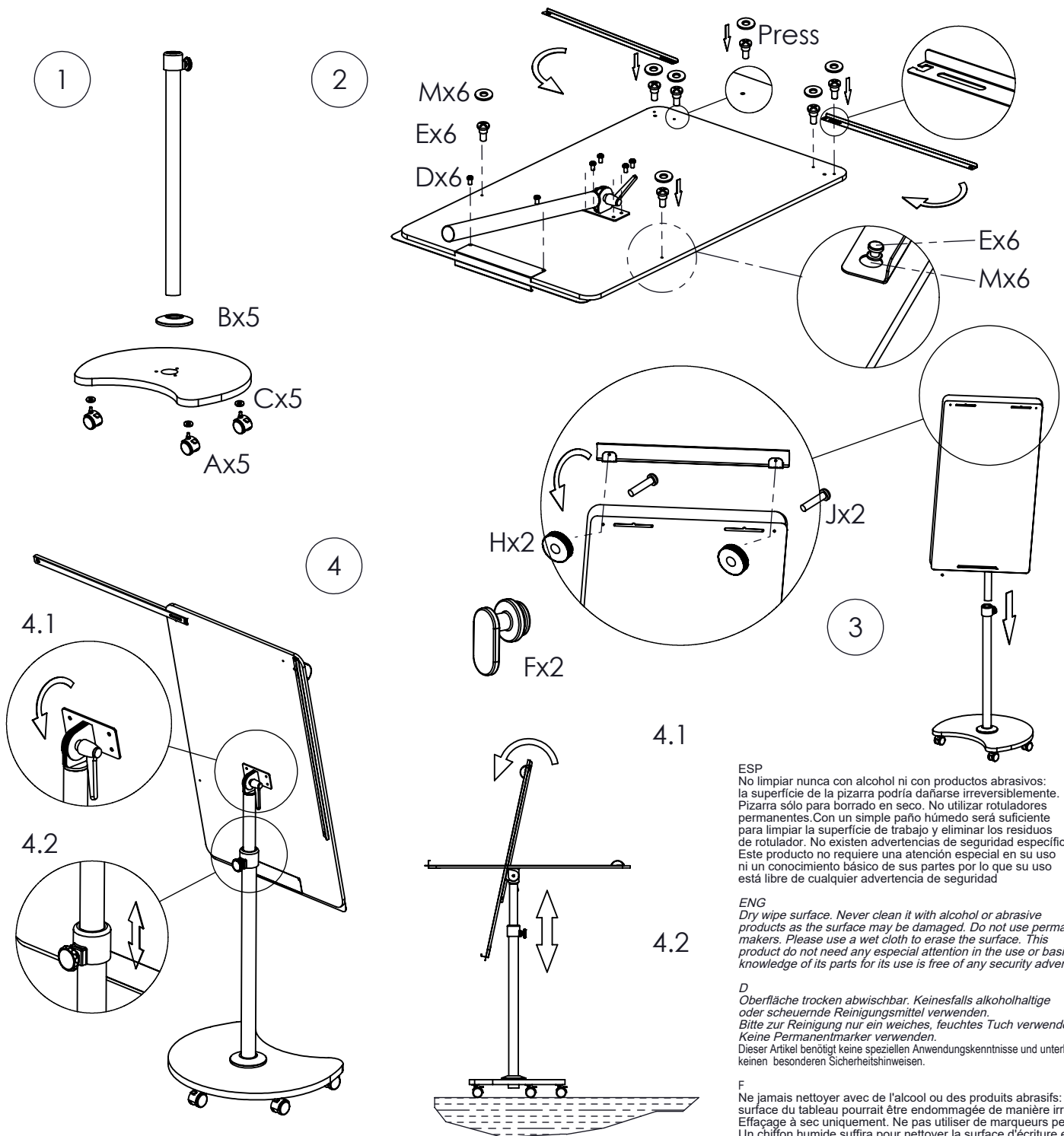

ESP
No limpiar nunca con alcohol ni con productos abrasivos: la superficie de la pizarra podría dañarse irreversiblemente. Pizarra sólo para borrado en seco. No utilizar rotuladores permanentes. Con un simple paño húmedo será suficiente para limpiar la superficie de trabajo y eliminar los residuos de rotulador. No existen advertencias de seguridad específicas. Este producto no requiere una atención especial en su uso ni un conocimiento básico de sus partes por lo que su uso está libre de cualquier advertencia de seguridad.

ENG
Dry wipe surface. Never clean it with alcohol or abrasive products as the surface may be damaged. Do not use permanent makers. Please use a wet cloth to erase the surface. This product do not need any especial attention in the use or basic knowledge of its parts for its use is free of any security advertise

D
Oberfläche trocken abwischbar. Keinesfalls alkoholhaltige oder scheuernde Reinigungsmittel verwenden. Bitte zur Reinigung nur ein weiches, feuchtes Tuch verwenden. Keine Permanentmarker verwenden. Dieser Artikel benötigt keine speziellen Anwendungskennnisse und unterliegt keinen besonderen Sicherheitshinweisen.

F
Ne jamais nettoyer avec de l'alcool ou des produits abrasifs: La surface du tableau pourrait être endommagée de manière irréversible. Effaçage à sec uniquement. Ne pas utiliser de marqueurs permanents. Un chiffon humide suffira pour nettoyer la surface d'écriture et enlever les résidus de marqueur. Ce produit ne comporte pas d'avertissement de sécurité spécifique.